

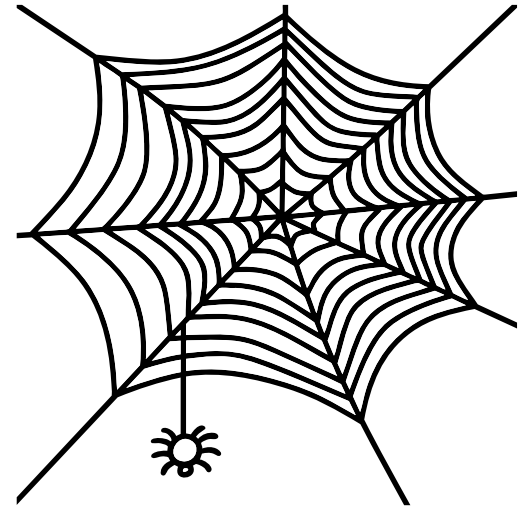

A **Letter W** Book



We see the web.

W W W



Preview

Please log in to download
the printable version of this worksheet.

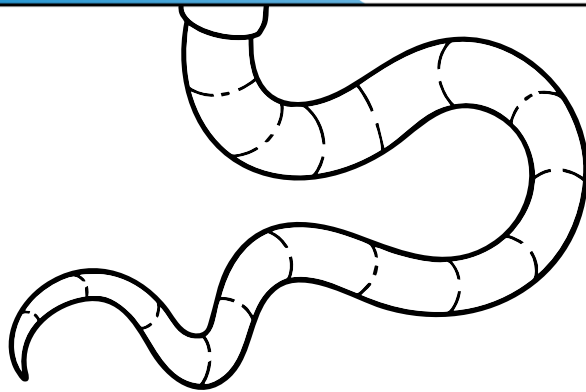

We see the worm.

W W W

worm

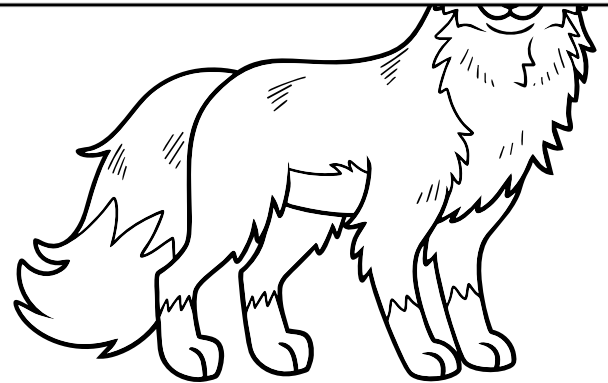

We see the wolf.

W W W

wolf

4

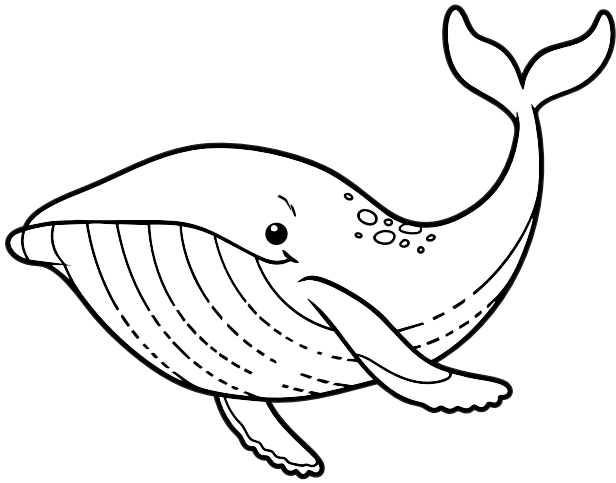

We see the whale.

w w w

5



We see the witch.

w w w

STAPLE

STAPLE

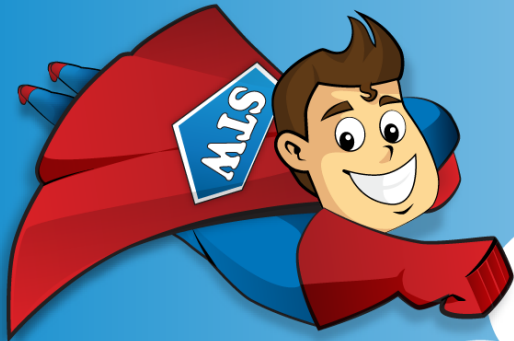

Preview

Please log in to download the printable version of this worksheet.

STAPLE

STAPLE

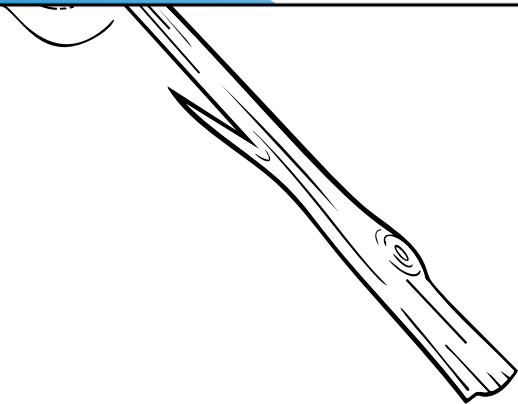

We see the wand.

w w w

wand

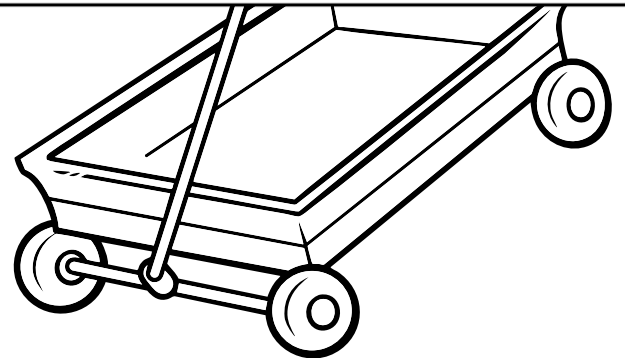

We see the wagon.

w w w

wagon