

Name: _____

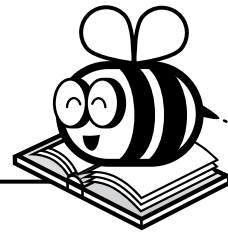

ELA Buzz



Metaphors compare two things that aren't alike but have something in common. They don't use words such as **like** or **as**.

Fill in the blank with a word from the box to make a metaphor showing there are lots of letters.

puddle sea stack

There's a whole _____ of letters on my desk!



Preview

Please log in to download the printable version of this worksheet.

envelopes



We bought three sheet of stamps.

Combine the two fragments into one complete simple sentence.

Jada wants to send. A heartfelt message.

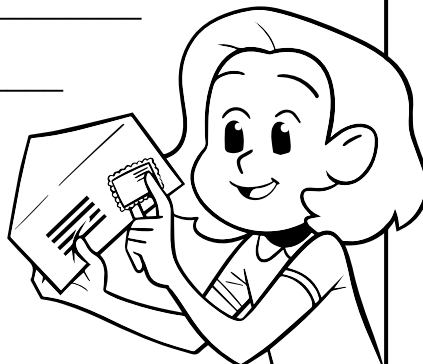

Which word is correctly divided into syllables?

collection

col-lec-tion

co-llec-tion

col-lect-ion

col-lecti-on



Name: _____

ELA Buzz

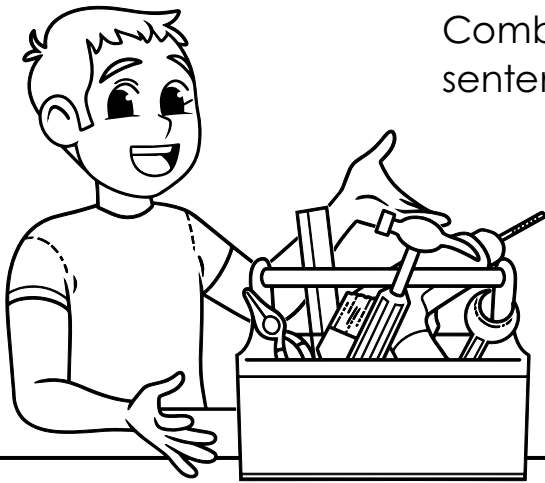
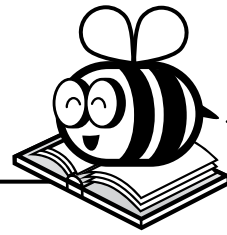

Combine the two simple sentences into one compound sentence using a comma and the word **but**.

Dad will fix the bathroom door. He needs some tools first.

Fill in the missing vowels to correctly

Rewrite the sentence below as a line of



Preview

Please log in to download the printable version of this worksheet.

Choose the coordinating conjunction from the box that best completes each sentence.

but nor or so

This power drill is small _____
surprisingly heavy.

Is that everything, _____ are
there still things to buy?

Fill in the blank with the word that best completes the sentence.

seeking looking searching

We are _____ the shelves for
the correct tools.

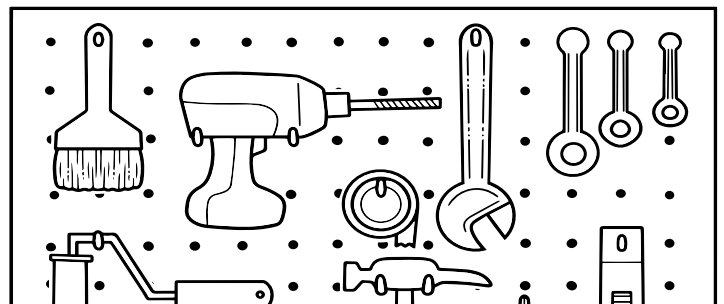

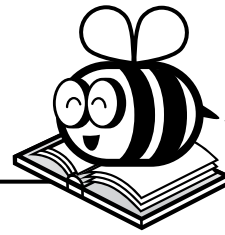

Name: _____

ELA Buzz

Add commas to make the sentence correct.

Common recyclable materials include glass paper metals like tin and certain plastics.



Rewrite the sentence correctly.

Greasy pizza boxes are'nt recyclabul.

3 errors



Preview

Please log in to download the printable version of this worksheet.

re •
cycl •

- circle
- again
- three
- not

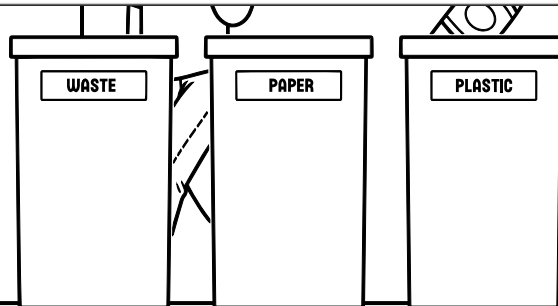

reuse
lessen
ignore



Say what part of speech the bold word is. Then say the part of speech of the word that it is describing.

Recycling is a **very** important step to helping the planet.

part of speech of the bold word: _____

part of speech it is describing: _____

Name: _____

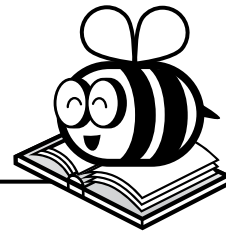

ELA Buzz

Kamilah and Molly are two peas in a pod.

What does *two peas in a pod* mean in this sentence?

- a. Kamilah and Molly like vegetables.
- b. Kamilah and Molly are very similar.
- c. Kamilah and Molly are wearing green.

What kind of figurative language is it?

- a. an idiom
- b. a simile



The two **girls'** friendship has

Fill in the chart with the tenses of the verb **do**.



common / proper

future

they

concrete / abstract

Rewrite the sentence correctly.

I hope youll spend the nite,
Molly sayed. (5 errors)

The girls are going to read from *101 Spooky Spirit Stories* once it gets dark.

Based on context, circle a synonym for **spirit**.

tale

lullaby

ghost



Name: _____

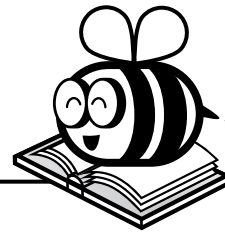

ELA Buzz

George Washington Carver was born around 1864. No one knows the exact year or date for sure because he was born enslaved.



However, that didn't stop Carver from becoming one of the greatest minds of the early 1900s. He went to school and became a

Choose the best article to complete the sentence.

a an the

George Washington Carver was _____ scientist who helped farmers.

Circle the synonym for



Preview

Please log in to download the printable version of this worksheet.

even restore its nutrients.

What genre of writing is this?

- a.** tall tale
- b.** biography
- c.** fiction

What was the author's purpose?

- a.** to teach a short history about someone
- b.** to tell an entertaining story about someone
- c.** to teach how to help farmers

Use context to give a definition for **restore**.

a book title.

carver: a life of science

Which word is correctly divided into syllables?

nutrients

nu-tri-ents

nut-rien-ts

nu-trient-s

nut-rie-nts

Fill in the blank with a word from the box to make a metaphor showing there are lots of letters.

puddle sea stack

Add punctuation to make the sentence correct.

We'll need paper, some stamps, and a few envelopes.

Check the box next to the sentence with no errors. Circle the errors in the other sentences.

I'm writing several thank-you letters to my family.

Combine the two fragments into one complete simple sentence.

Jada wants to send. A heartfelt message.

Jada wants to send a

Which word is correctly divided into syllables?

collection

col-lec-tion

collec-tion

Preview

Please log in to download the printable version of this worksheet.



What genre of writing is this?

b. biography

What was the author's purpose?

a. to teach a short history about someone

Use context to give a definition for *restore*.

to bring back; to give back

Choose the best article to complete the sentence.

a an the

George Washington Carver was a scientist who helped farmers.

Circle the synonym for *invented*.

located **created**

enjoyed noticed

Rewrite the title below using the correct capitalization for a book title.

carver: a life of science

Carver: A Life of Science

Which word is correctly divided into syllables?

nutrients

nu-tri-ents nut-rien-ts

nu-trient-s nut-rie-nts