

Name: _____

Perimeter of a Polygon

Find the perimeter of each polygon.

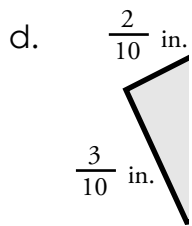
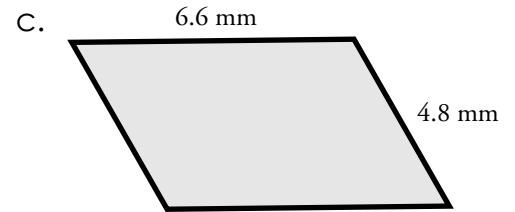
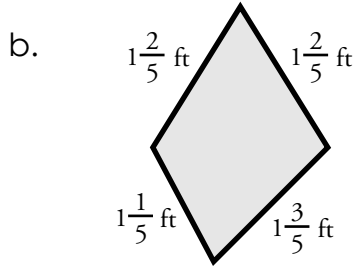
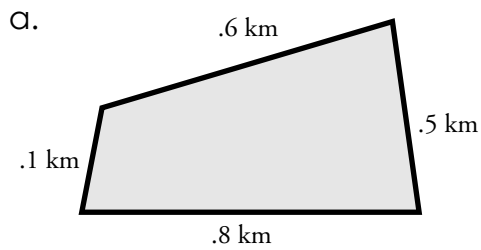

PREVIEW

Please log in or register to download the printable version of this worksheet.

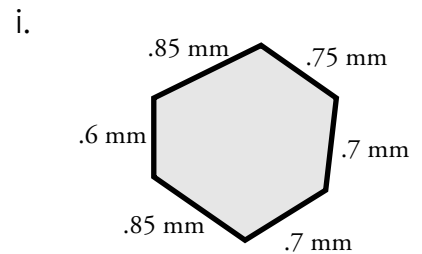
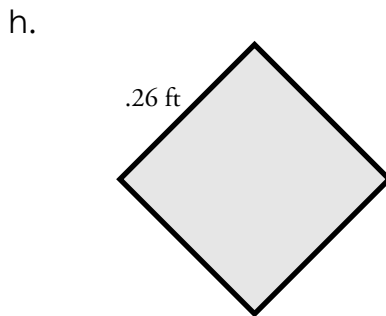
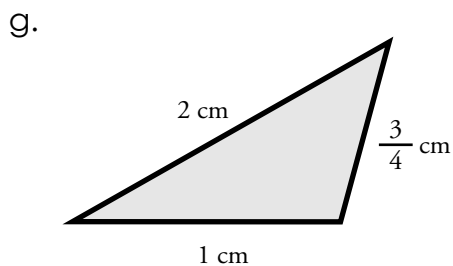
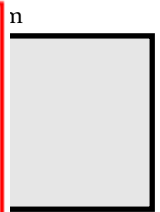

ANSWER KEY

Perimeter of a Polygon

Find the perimeter of each polygon.

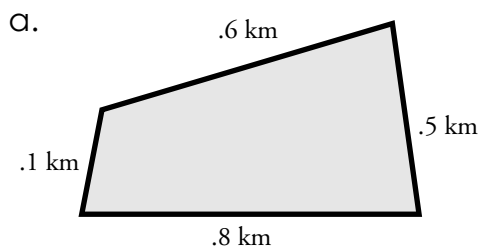

2.0 km

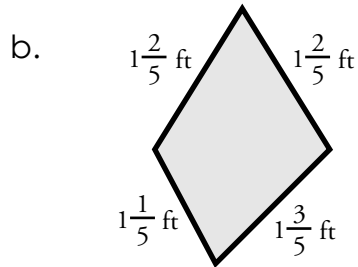

$5\frac{3}{5}$ ft

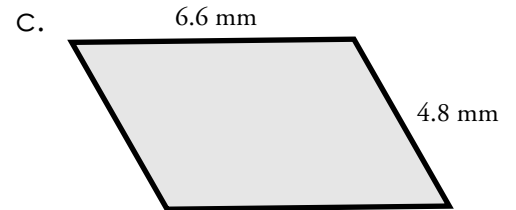

22.8 mm

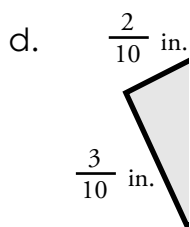

PREVIEW

Please log in or register to download the printable version of this worksheet.

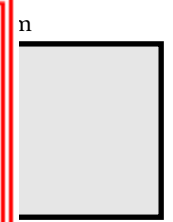

1 in.

15.9 cm

51 m

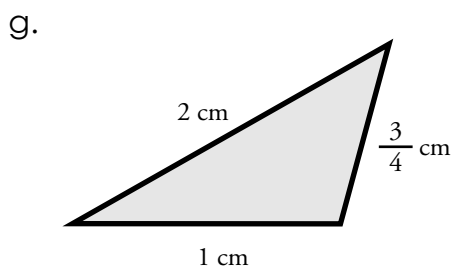

$3\frac{3}{4}$ cm

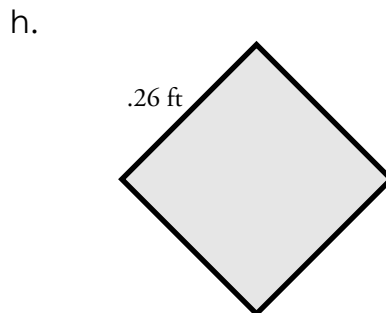

1.04 ft

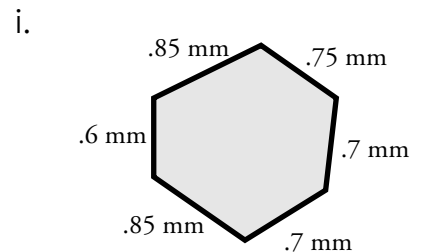

4.45 mm